



CANE CREEK®

DB

KITSUMA

INSTRUCTION MANUAL

EVERY RIDE *IS DIFFERENT*

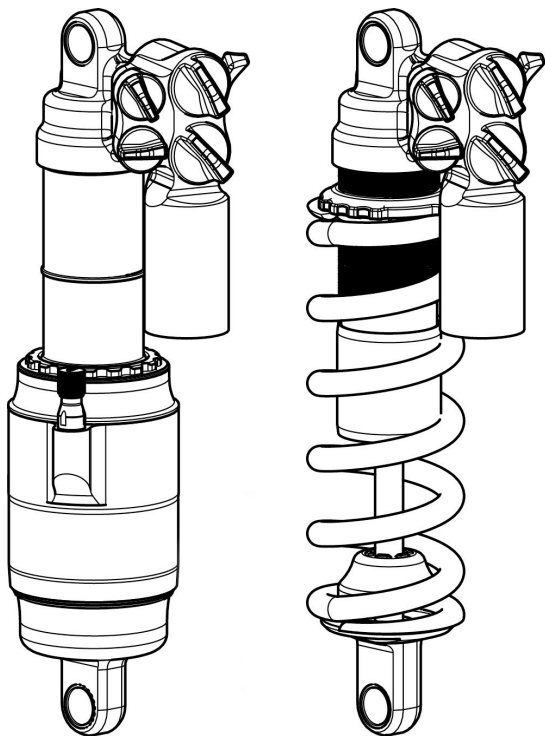

Table of Contents



3	Safety and Warning Information
5	Introduction and Registration
6	Features Overview
7	Product Anatomy
9	Adjuster Basics
11	Frame Clearance
13	Installation
15	Setting Sag
19	Air Volume Adjust
21	Coil Installation
22	Service and Maintenance
23	Warranty Information
25	Tuning Field Notes



Safety and Warnings

The rear shock is an important part of your bike. Before installing and using your new rear shock, carefully read this owner's manual to learn the correct installation and adjustment procedures of the shock.

Warning

Improperly installed and/or adjusted shocks can cause serious harm or death and may severely damage your bike.

Warning

A broken or malfunctioning shock may cause loss of vehicle control and result in **SERIOUS INJURY OR DEATH**. If the shock ever loses oil, air or makes unusual noises, stop riding and have the shock inspected by a Cane Creek Authorized Suspension Service Center or call the Cane Creek Customer Service Team.

Warning

Modification, improper service or use of aftermarket replacement parts voids the warranty and may cause the shock to malfunction, resulting in loss of vehicle control and **SERIOUS INJURY OR DEATH**. Do not modify your bike frame or shock. Use only genuine Cane Creek Double Barrel parts.



Follow service maintenance recommendations. Shock service should be performed by Cane Creek Cycling Components or a Cane Creek Authorized Suspension Service Center. Visit www.CaneCreek.com or contact us at **800-234-2725** to locate a Cane Creek Authorized Suspension Service Center.

Cane Creek rear shocks contain a nitrogen charge in the reservoir. Opening a nitrogen pressurized shock is dangerous and can result in **SERIOUS INJURY OR DEATH**. The shock should only be opened by a Cane Creek Authorized Suspension Service Center.

Cane Creek rear shocks are manufactured exclusively for the bike model for which they are ordered. Switching units between different bikes may not only decrease the shocks performance but might also cause damage to the bike and can result in **SERIOUS INJURY OR DEATH**. Always contact Cane Creek or Cane Creek Authorized Suspension Service Center to verify compatibility before switching a shock from one bike to another.

Any improper servicing procedure with a Cane Creek shock with “stuck down” condition can lead to **SERIOUS INJURY OR DEATH**. Contact Cane Creek or an Authorized Suspension Service Center for repair.



Congratulations on the purchase of your Cane Creek DB Kitsuma rear shock.

Cane Creek has been supplying revolutionary suspension technology to the bicycle market since 2005. Based on a foundation of precision quality and cutting-edge innovation, our rear shocks represent the pinnacle of high-performance bicycle suspension systems. Cane Creek technology offers the broadest adjustment range available giving you the control to tune your shock, your way, for your bike. This owner's manual is your reference guide to understanding and tuning your DB Kitsuma rear shock. It also provides important information about proper installation, set-up and maintenance of your shock.

For product registration or questions, visit **www.CaneCreek.com** or contact the Cane Creek Customer Service Team ready to help you at 800-234-2725.

Features Overview



END EYE	Open ID	ID w/Bushing	Trunnion
Air & Coil	15.02	12.7mm	54mm Width / M10 Threads
Damper Adjustments	Adjuster	Abbreviation	Positions
Air & Coil	Low Speed Compression	LSC	11
	Low Speed Rebound	LSR	11
	High Speed Compression	HSC	13
	High Speed Rebound	HSR	13
	Climb Switch	CS	3
Spring Rates	Minimum	Maximum	Sag
Air Pressure	50psi	300psi	Recommended 25% - 35%
Coil Preload	1 turn	6 turns	

Count of adjuster positions may vary slightly with some shock builds. The range of adjustment will remain the same.



AIR

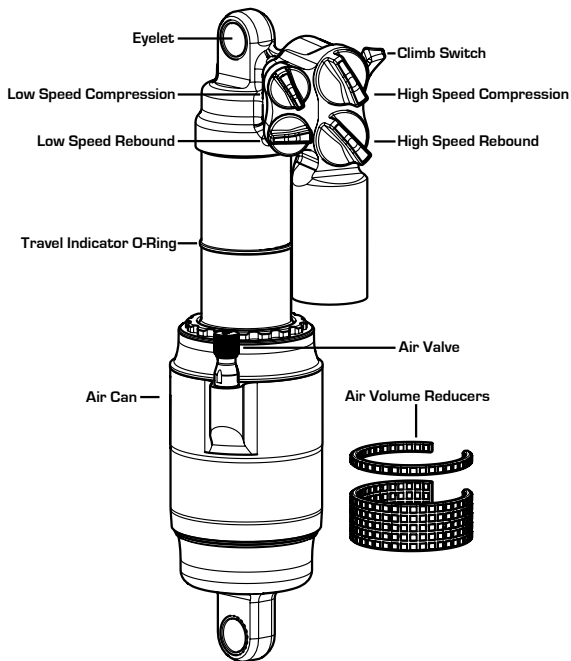



COIL

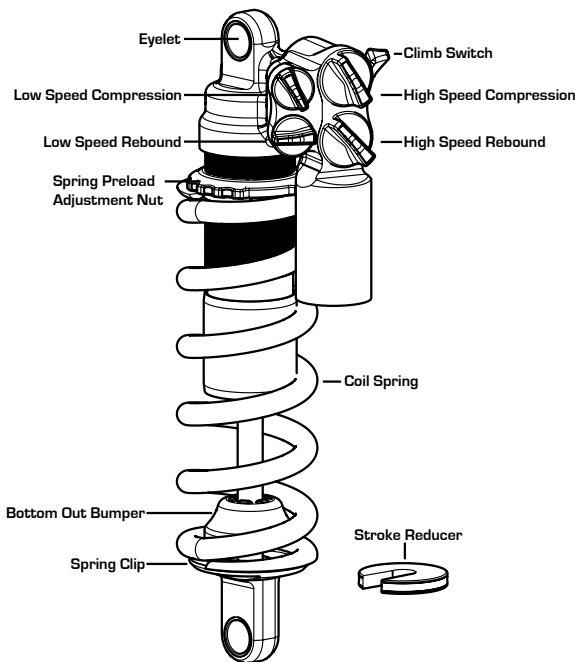



Adjuster Basics

Compression and Rebound are settings used to control the speed at which the shock is compressed and uncompressed during suspension events. When adjusting these settings, you are adjusting the rate of oil flow in the shock damper system. A Cane Creek “DB” shock has the following settings.

Low Speed Compression (LSC) - Shaft compression during most compression events. (i.e. Most bumps in a trail or pedal “bob”)

High Speed Compression (HSC) - Shaft compression during quick and large compression events. (i.e. Hard landing or deep compression)

Low Speed Rebound (LSR) - Shaft rebound speed during most rebound events (i.e. Recovering from compression cycles caused by pedaling or bumps.

High Speed Rebound (HSR) - Shaft rebound speed during quick and large rebound events, typically deep in the shock’s travel. (i.e. Recovering from a hard landing or taking off from a jump lip)

Climb Switch-

1 - **“Open”** setting.
The lever does not add any additional damping to the shock - only the adjusters on the front face of the shock are influencing the shock’s movement in this setting.

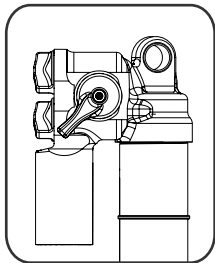



2 - “Climb” setting

The lever closes the Low Speed circuit of the shock in this setting, creating a firmer feel and stops the shock from bobbing in pedaling scenarios. This setting is designed for on-trail climbing support where the shock is still active during fast impacts (i.e.. fallen log, roots, rocks) but removes the rider influenced soft bump absorption.

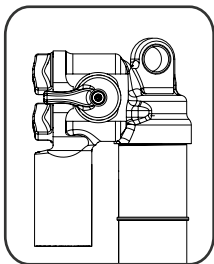

3 - “Firm” setting

The lever closes both Low Speed and High Speed circuits of the shock in this setting, effectively stopping the flow of oil through the shock. This setting is designed for long pavement or gravel climbs where the uphill lasts hours and you don't want the shock taking away pedaling efficiencies.

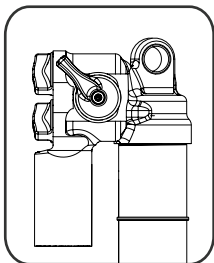

DB Kitsuma features tool free adjustments with all adjusters clearly labeled on the shock. Turning an adjuster counter clockwise will open the circuit which allows more oil flow. (open compression = soft compression / open rebound = fast return speed) Turning an adjuster clockwise will close the circuit and restrict oil flow. (closed compression = firm compression / closed rebound = slow return speed).



Frame Clearance

It is critical to check for clearance between your frame and shock at all points of travel during installation of the shock. The eye to eye and stroke measurements of the shock must match what is specified and approved by the frame manufacturer.

Follow the steps below carefully to ensure proper clearances and avoid damage.

AIR - These steps must be followed when installing a new shock to ensure proper clearance between your frame and the shock at all points of travel.

1. Install the shock to your frame using the appropriate hardware as specified by your frame manufacturer. Refer to installation section (pg.13).
2. With a shock pump attached to the air valve, slowly release the air pressure in the shock. Up to 50psi may be left in the shock if desired. Ensure that the Climb Switch is in the off position.
3. Slowly compress the suspension fully through its travel while ensuring there is no interference between the shock and the frame. If needed, the air can is rotatable by hand for best alignment of the air valve.

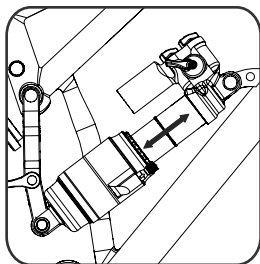



4. If there is sufficient clearance, add air pressure back to the shock. A suggested starting point for PSI is 75% - 100% of rider's weight (lbs) in psi. Cycle the shock 10-20 times through at least 30% of its travel to equalize the positive and negative pressure. Check and adjust the air pressure again after equalizing as some pressure will have transferred to the negative chamber.

COIL - These steps must be followed when installing a new shock to your frame to ensure proper clearance between your frame and the shock at all points of travel.

1. Remove the spring from the shock and install only the spring clip. Refer to coil installation section (pg.21).
2. Install the shock to your frame using the appropriate hardware as specified by your frame manufacturer. Ensure that the Climb Switch is in the off position.
3. Slowly compress the suspension fully through its travel while ensuring there is no interference between the shock and the frame.
4. If there is sufficient clearance, remove the shock to install the coil.
5. Reinstall the complete shock to the frame to set sag.

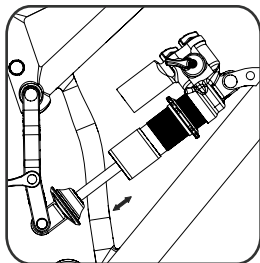



Installation

Installation of the shock requires the use of the appropriate hardware for your specific frame. The mounting points of the shock are a standardized size and additional hardware is typically needed to fit the shock to each frame. Shock hardware may be needed to properly take up the width and thickness of the frame's mounting points and bolts. The size and type of shock hardware required should be listed by the manufacturer or by measuring the existing hardware used in the frame.

For eyelet bushing and hardware installation information, please visit **www.CaneCreek.com**.

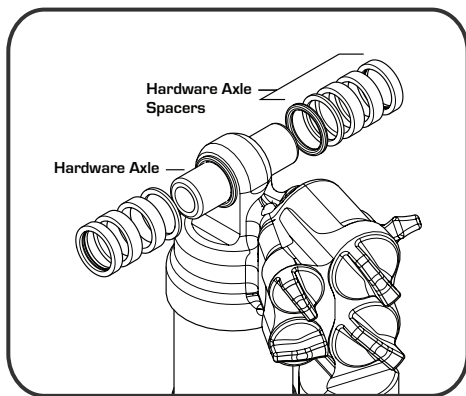



1. With the appropriate hardware installed to the shock eyelets, mount the shock to the frame by first inserting the mounting bolts. Do not force the shock in place if there is any fitment interference with the frame.

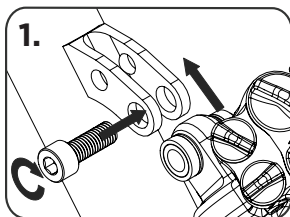

2. Torque all mounting bolts to the frame manufacturer's specifications.

3. Ensure all hardware is secure and there is no side to side movement allowed at either mounting point.

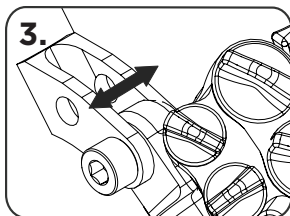



Setting Sag

Sag is the point at which your shock is compressed under neutral riding weight. This is the most important setting of your shock and will have the greatest impact on the shock's effectiveness. Typical recommended sag for shocks is between 25% and 35% of the shock's travel. The best setting for you will be determined by your specific ride feel and suspension kinematics. We recommend a starting point of 30% of shock travel but this may need to be adjusted to your needs.

For updated tutorials and suggestions, visit
www.CaneCreek.com.

Air

Starting point of air pressure - recommended starting point is 75% - 100% of rider's weight (lbs) in psi.

Example = 180lbs rider = 135psi. - 180psi

*This will vary between shock sizes and suspension kinematics.

1. With starting air pressure in the shock and the Climb Switch in the Open position, ensure the positive and negative air chambers are equalized by cycling the shock 10-20 times through at least 30% of its travel.

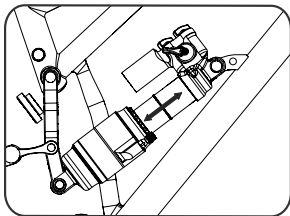



2. Slide the Travel Indicator O-ring to the shock body and mount the bike in your normal riding gear. Ensure the bike is on a level surface and your weight is centered over the bottom bracket as you are in a normal riding position.

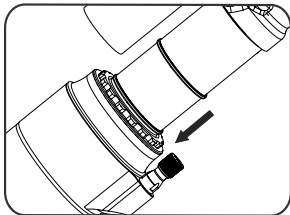

3. Carefully dismount the bike without further compressing the suspension and measure the distance the O-ring has moved.

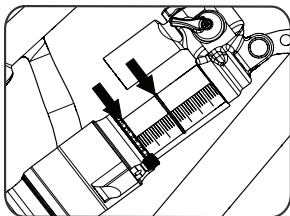

4. This distance is your sag amount and can be converted to a percentage with the following formula. $(\text{Sag} / \text{Shock Stroke}) \times 100 = \text{Sag Percentage}$ (E.g. $(16.5\text{mm} / 55\text{mm stroke}) \times 100 = 30\%$)
5. Add or remove air pressure as needed and repeat the process until desired sag amount is achieved.



Setting Sag

Coil

For a recommended starting coil weight, visit www.CaneCreek.com or contact the Cane Creek Customer Service Team ready to help you at 800-234-2725.

IMPORTANT

If less than 1 turn of preload engagement is needed to achieve proper sag, you will need to change to a lower spring rate. If more than 6 turns of preload are needed to achieve proper sag, you will need to change to a stiffer (higher rate) spring.

Increasing Spring Preload

Increasing the preload will increase the ride height and reduce sag. To increase the preload on your spring, turn the Spring Adjustment Nut clockwise (no more than six turns).

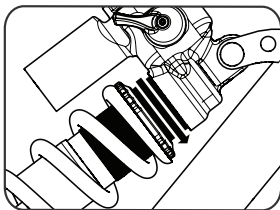

Reducing Spring Preload

Reducing the preload will decrease the ride height and increase sag. To reduce the preload on your spring, turn the Spring Adjustment Nut counter-clockwise (Make sure the spring preload still has 1 full turn of preload engagement when reducing preload).

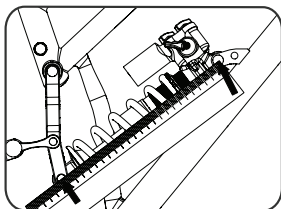
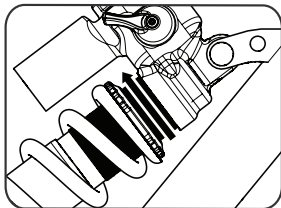

1. With the shock uncompressed, measure the length of your shock from eye to eye.
2. Mount the bike in your normal riding gear. Ensure the Climb Switch is in the Open position, the bike is on a level surface, and your weight is centered over the bottom bracket as you are in a normal riding position.
3. Measure the shock from eye to eye in this position. The difference between the two measurements is your sag amount (uncompressed length - compressed length = sag) and can be converted to a percentage with the following formula. (Sag / Shock Stroke) X 100 = Sag Percentage (E.g. (16.5mm / 55mm stroke) X 100 = 30%)
4. Add or remove spring pre-load as needed and repeat the process until desired sag amount is achieved.



Air Volume Adjustment

Air volume can be adjusted by adding volume reducing spacers inside of the air can. This adjustment causes the air spring to ramp up at the end of the shock's travel which will further increase the resistance to bottom out.

Air pressure should be only used to achieve the correct sag value. If the sag measurement of your air shock is correct (between 25-35% of the shock's stroke is compressed with the rider weight positioned properly on the bike) but the bike uses all of the shock's travel too easily or too frequently, consider adding a volume reduction spacer to the shock.

To install volume reduction spacers:

1. Slowly release air from the shock. **WARNING** Failure to remove air pressure before opening the shock body can result in serious injury.

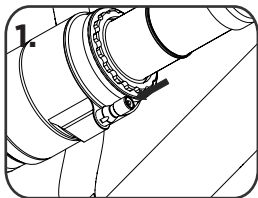

2. Remove the retaining O-ring from the outer air canister

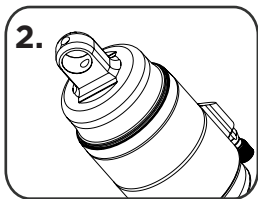



3. Pull the outer air canister down until it separates from the shock

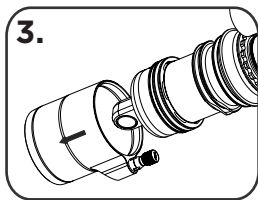

4. Install the desired amount of volume reduction spacers
* Large volume reducer bands can be cut to smaller sections if needed.

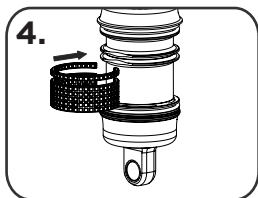

5. Reinstall the outer air can

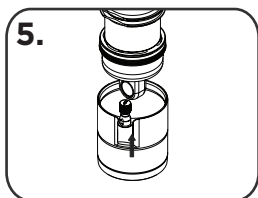

6. Reinstall the retaining O-ring ensuring that it is fully seated in the groove

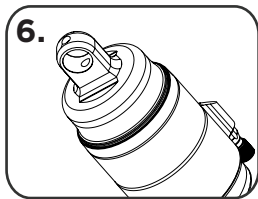

7. Using a shock pump, inflate the shock and set sag



Coil Installation

Selecting the appropriate spring rate is an important variable in achieving optimal set-up of a coil shock. Your ideal spring rate will be based on rider weight, frame design, and riding style. (For spring weight calculation help, visit www.CaneCreek.com or call the Cane Creek Service Team).

Warning

Riding on a spring that is not appropriate for your body weight can cause **SERIOUS INJURY OR DEATH** and damage to the bike and shock.

Spring Removal and Installation

To remove the spring, turn the spring adjustment nut until it touches the cylinder head. Remove spring clip from shock. Once the clip is removed, slide the spring off the shock. On frames with long mounting axles, it may be necessary to remove the mounting axle before the spring can be removed.

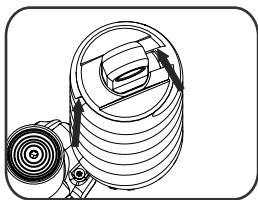
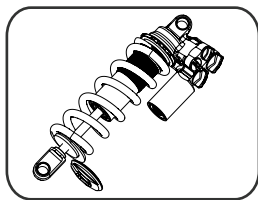

Warning

Always make sure the end of the spring's coil is aligned on the opposite side of the slot in the spring clip.

Service and Maintenance



Extreme usage like downhill racing or ebikes may shorten service intervals.

Service and Maintenance	Every Ride	15 Hours	100 Hours or annually
Check sag - Reset if necessary	X		
Clean and inspect shock exterior	X		
Clean with mild soap and water		X	
(AIR) Inspect external air sealing surfaces for scratches or damage.		X	
(AIR) Inspect and clean air valve threads to prevent dirt from entering air spring during inflation.		X	
(COIL) Clean around spring adjustment nut to prevent damage to the threads on shock body.		X	
Inspect mounting hardware and bushings.		X	
Service damper and air spring performed by a Cane Creek Authorized Service Center.			X



Warranty Information

LIMITED ONE (1) YEAR WARRANTY ON SUSPENSION PRODUCTS

Subject to the limitations, terms and conditions here of, Cane Creek warrants, to the original retail owner of each new Cane Creek suspension product, that the Cane Creek suspension product, when new, is free from defects in materials and workmanship. This warranty expires one (1) year from the date of the original Cane Creek suspension product retail purchase from an authorized Cane Creek dealer or from a Cane Creek authorized original equipment manufacturer where Cane Creek suspension is included as original equipment on a purchased bike, unless otherwise dictated by requirement of law.

TERMS OF WARRANTY

This warranty is conditioned on the Cane Creek suspension product being operated under normal conditions and properly maintained as specified by Cane Creek. This warranty is only applicable to Cane Creek suspension purchased new from an authorized Cane Creek source and is made only to the original retail owner of the new Cane Creek suspension product and is not transferable to subsequent owners. This warranty is void if the Cane Creek suspension product is subjected to abuse, neglect, improper or unauthorized repair, improper or unauthorized service or maintenance, alteration, modification, accident or other abnormal, excessive, or improper use. Should it be determined, by Cane Creek in its sole and final discretion, that a Cane Creek suspension product is covered by this warranty, it will be repaired or replaced, by a comparable model, at Cane Creek's sole option, which will be conclusive and binding.

THIS IS THE EXCLUSIVE REMEDY UNDER THIS WARRANTY.



ANY AND ALL OTHER REMEDIES AND DAMAGES THAT MAY OTHERWISE BE APPLICABLE ARE EXCLUDED, INCLUDING, BUT NOT LIMITED TO, INCIDENTAL OR CONSEQUENTIAL DAMAGES OR PUNITIVE DAMAGES.

This limited warranty does not apply to normal wear and tear, malfunctions or failures that result from abuse, improper assembly, neglect, alteration, improper maintenance, crash, misuse or collision. Subject to the terms and conditions of this warranty, leaking seals will be replaced within 90 days from the original date of purchase. Such replacement notwithstanding, seals are subject to relative movement between parts and are normal wear and-tear items not subject to warranty coverage. This limited warranty gives the consumer specific legal rights. The consumer may also have other legal rights which vary from state to state or country to country. Some states and countries do not allow the exclusion or limitation of incidental or consequential damages or warranties, so the above limitations or exclusions may not apply to you. If it is determined by a court of competent jurisdiction that a certain provision of this limited warranty does not apply, such determination shall not affect any other provision of this limited warranty and all other provisions shall remain in effect.

THIS IS THE ONLY WARRANTY MADE BY CANE CREEK ON ITS SUSPENSION PRODUCTS AND COMPONENTS, AND THERE ARE NO WARRANTIES THAT EXTEND BEYOND THE DESCRIPTION HEREIN. ANY WARRANTIES THAT MAY OTHERWISE BE IMPLIED BY LAW INCLUDING, BUT NOT LIMITED TO, ANY IMPLIED WARRANTY OF MERCHANTABILITY OR FITNESS FOR A PARTICULAR PURPOSE ARE EXCLUDED.



Tuning Field Notes

DATE

TRAIL

AIR PRESSURE

or

COIL SPRING RATE

PRELOAD

SAG

VOLUME REDUCTION

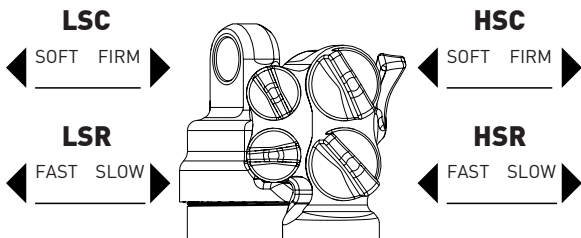

NOTES

Tuning Field Notes



DATE

TRAIL

AIR PRESSURE

or

COIL SPRING RATE

PRELOAD

SAG

VOLUME REDUCTION

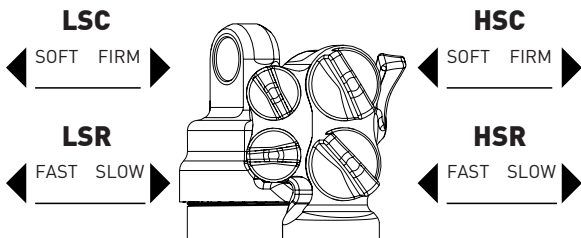

NOTES



Tuning Field Notes

DATE

TRAIL

AIR PRESSURE

or

COIL SPRING RATE

PRELOAD

SAG

VOLUME REDUCTION

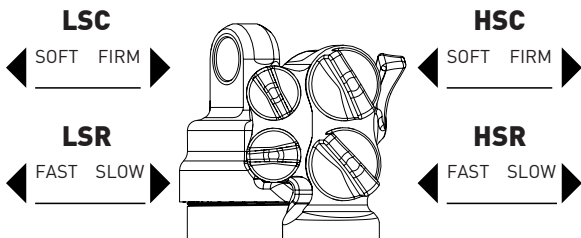

NOTES

Tuning Field Notes



DATE

TRAIL

AIR PRESSURE

or

COIL SPRING RATE

PRELOAD

SAG

VOLUME REDUCTION

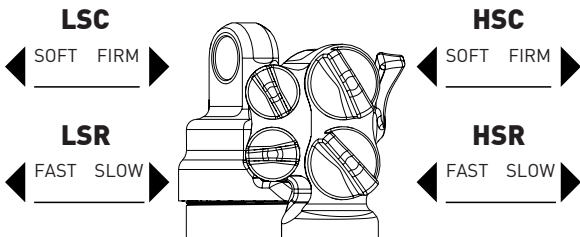

NOTES



Cane Creek Cycling Components
355 Cane Creek Rd
Fletcher North Carolina 28732
1.800.234.2725
canecreek.com
service@canecreek.com

AAC0252